

XS WIRELESS

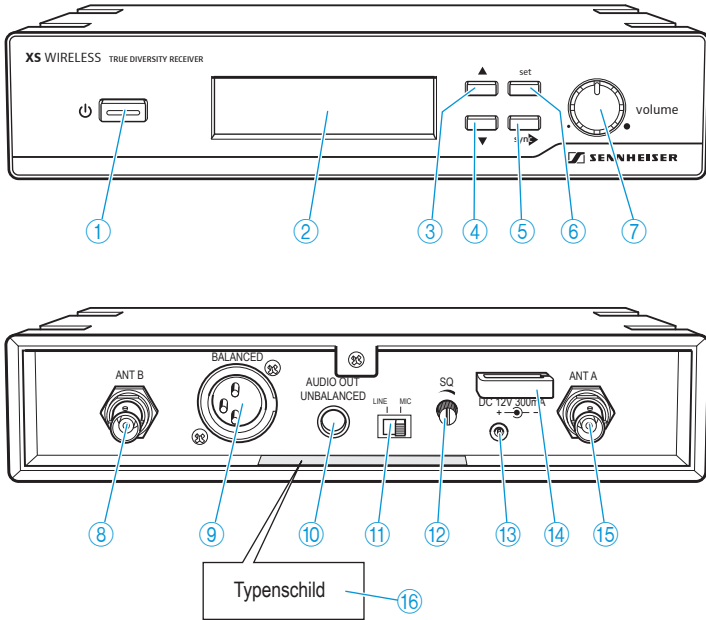
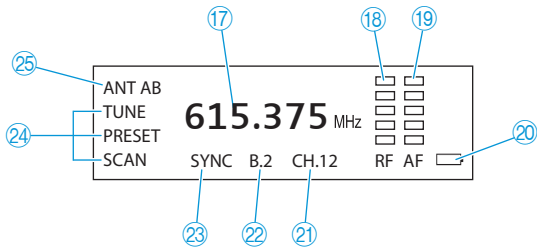

Instruction manual

A**B**

C

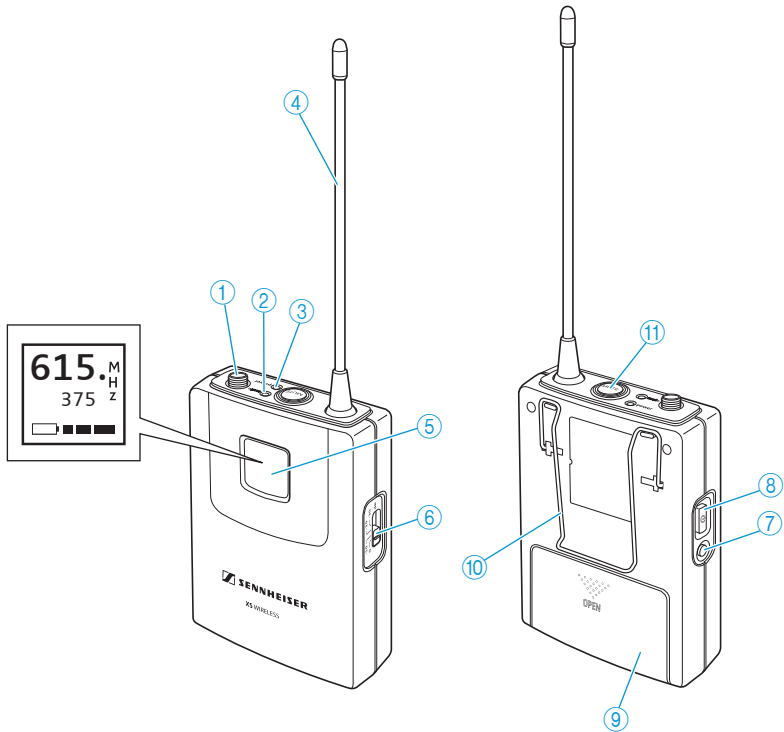

D

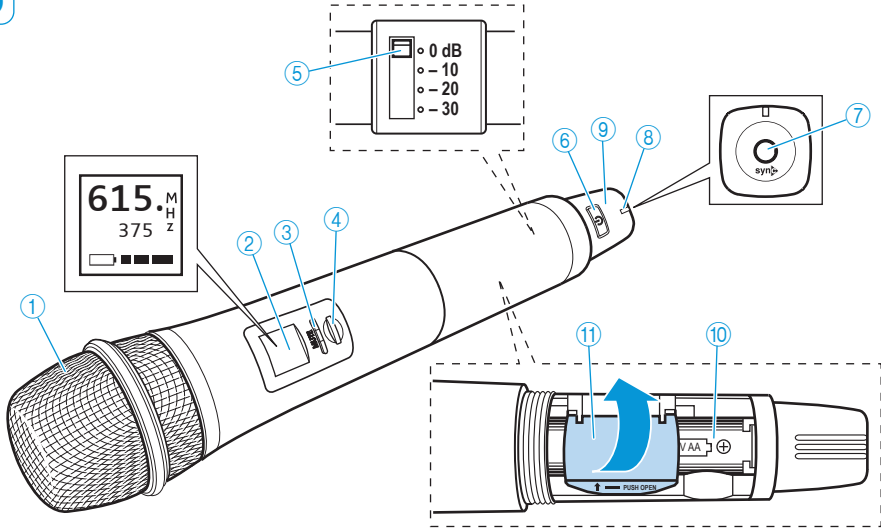

Frequenz- und Sendeleistungsübersicht
 Frequency and transmission power overview
 Aperçu des fréquences et puissances d'émission spécifiques
 Panoramica di frequenze e prestazioni di trasmissione
 Relación de frecuencias y potencias de transmisión
 Overzicht van landspecifieke frequenties en zendvermogens
 Vista geral das frequências e da potência de transmissão
 Обзор частот и мощностей передачи
 频率和发射功率总览

European Nations and her international abbreviations		Frequency range (MHz)	max. RF_power (mW – erp.)	individual licence required
All listed countries (not Norway)		863 – 865	10	no
Austria Cyprus Greece	AT CY GR	470 – 862	50	yes
Belgium	BE	470 – 608, 608 – 862	50 (20)	yes
Germany	DE	470 – 606, 614 – 790	50	yes
		823 – 832	50	–
Great Britain	GB (UK)	606 – 614 (Ch. 38 mobile)	50	yes
		470 – 860	–	–
Italy	IT	470 – 854	10 & 50	yes
Liechtenstein Switzerland	LI CH	470 – 862	50	yes
Norway	NO	800 – 820	20 mW	–
		790 – 800 & 820 – 838	–	
Romania	RO	646 – 759	30	yes

Contents

- Important safety instructions 2
- The **XS** WIRELESS systems 4
- Delivery includes 5
- Product overview 6
 - EM 10 receiver 6
 - SK 20 bodypack transmitter 6
 - SKM 35/SKM 65 radio microphone 6
- Putting the **XS** WIRELESS systems into operation 7
 - Putting the receiver into operation 7
 - Putting the bodypack transmitter into operation 8
 - Putting the radio microphone into operation 8
- Using the **XS** WIRELESS systems 9
 - Switching the receiver on/off 9
 - Switching the transmitters on/off 9
 - Muting the transmitters 10
 - Adjusting the sensitivity 10
 - Selecting and changing a receiver channel 10
 - Synchronizing a transmitter with the receiver 11
 - Adjusting the squelch threshold 11
- Cleaning and maintaining the **XS** WIRELESS systems 12
- If a problem occurs 12
- Specifications 13
- Manufacturer Declarations 16



Important safety instructions

System

- Read this instruction manual.
- Keep this instruction manual. Always include this instruction manual when passing the products on to third parties.
- Heed all warnings and follow all instructions in this instruction manual.
- Only clean the products when they are not connected to the mains. Use a cloth for cleaning.
- Only use attachments/accessories specified by Sennheiser.
- Refer all servicing to qualified service personnel.
Servicing is required if the products have been damaged in any way, liquid has been spilled, objects have fallen inside, the products have been exposed to rain or moisture, do not operate properly or have been dropped.
- **WARNING:** To reduce the risk of fire or electric shock, do not use the products near water and do not expose them to rain or moisture.

Receiver

- Only use the supplied mains unit.
- Unplug the mains unit from the wall socket,
 - to completely disconnect the product from the mains,
 - during lightning storms or
 - when unused for long periods of time.
- Only operate the mains unit from the type of power source specified in the chapter “Specifications” (see page 13).
- Ensure that the mains unit is
 - in a safe operating condition and easily accessible,
 - properly plugged into the wall socket,
 - only operated within the permissible temperature range,
 - not covered or exposed to direct sunlight for longer periods of time in order to prevent heat accumulation (see “Specifications” on page 13).
- Do not block any ventilation openings. Install the products in accordance with the instructions given in this instruction manual.
- Do not install the products near any heat sources such as radiators, stoves, or other devices (including amplifiers) that produce heat.
- Do not overload wall outlets and extension cables as this may result in fire and electric shock.
- Ensure that the mains unit is always accessible so that the connected product can be easily disconnected from the mains at any time.

Bodypack transmitter and radio microphone

- Do not place the products near any heat sources such as radiators, stoves, or other devices (including amplifiers) that produce heat.
- **WARNING:** These products should be protected against the ingress of liquids (eg: water, sweat, etc.) as this can cause malfunctions due to shortages or corrosion, etc.

Intended use

Intended use of the product of the **XS WIRELESS** systems includes:

- having read this instruction manual especially the chapter "Important safety instructions" on page 2,
- using the products within the operating conditions and limitations described in this instruction manual.

"Improper use" means using the products other than as described in these instructions, or under operating conditions which differ from those described herein.

Framework requirements and restrictions on frequency usage

Before putting your radio microphone system or other audio transmission systems into operation, ask the relevant wireless regulatory authority for the exact frequency allocations and apply for an individual license if necessary. The table on the inside back cover provides an overview of the different European framework requirements and restrictions on frequency usage. If there is no entry in the supplement, ask the relevant wireless regulatory authority for the current rules governing frequency usage.

DE

EN

FR

IT

ES

NL

PT

RU

ZH

The XS WIRELESS systems

Designed for different areas of application, the XS WIRELESS systems are available in five variants.

Presentation Set XSW 12: This system is ideal for presentation applications. The unobtrusive ME 2-2 clip-on microphone is virtually invisible.

Instrument Set XSW 72: This system is for connecting musical instruments (e.g. guitar) which have a 1/4" (6.3 mm) jack socket directly to the bodypack transmitter.

Vocal Set XSW 35 and Vocal Set XSW 65: These systems are ideal for vocal and speech applications.

Headset Set XSW 52: The lightweight and comfortable headset system gives absolute freedom of movement for a more animated and impressive performance. High-quality microphone technology provides clear, brilliant sound.

The XS WIRELESS systems are available in five UHF frequency ranges with 960 frequencies per frequency range (except range E = 520 frequencies). Each frequency range (A, GB, B, C, E) offers 8 frequency banks with up to 12 channels each. The frequency banks contain factory-preset frequencies (frequency presets).

Frequency range A	548 to 572 MHz
Frequency range GB	606 to 630 MHz
Frequency range B	614 to 638 MHz
Frequency range C	766 to 790 MHz
Frequency range E	821 to 832 MHz and 863 to 865 MHz

Features

- Up to 12 transmission links per frequency range which can be operated simultaneously
- Reliable transmission technology
- True diversity technology for minimizing dropouts in the reception
- Adjustable squelch for eliminating RF interference
- Rugged metal housing for EM 10 receiver
- Crystal-clear reception due to dynamic processor
- Sync function for wireless transmission of frequencies to transmitters
- Scan function searches for unused frequencies

Delivery includes

XS WIRELESS systems	Accessories												
	EM 10 receiver	SKM 35 radio microphone, dynamic	SKM 65 radio microphone, condenser	SK 20 bodypack transmitter	Transmitter bag	NT 2-3 mains unit	ME 2-2 clip-on microphone	CI 1 1/4" (6.3 mm) jack cable	MZQ 1 stand mount	ME 3 headmic	2 rod antennas	2 AA size batteries	Instruction manual
Vocal Set XSW 35	✓	✓			✓	✓			✓		✓	✓	✓
Vocal Set XSW 65	✓		✓		✓	✓			✓		✓	✓	✓
Presentation Set XSW 12	✓			✓	✓	✓	✓				✓	✓	✓
Instrument Set XSW 72	✓			✓	✓	✓		✓			✓	✓	✓
Headset Set XSW 52	✓			✓	✓	✓				✓	✓	✓	✓







A list of accessories can be found on the XS WIRELESS product page at www.sennheiser.com. For information on suppliers, contact your local Sennheiser partner: www.sennheiser.com > "Service & Support".

Product overview

An overview of the products is given on the inside front cover of this instruction manual.



A EM 10 receiver

- ① Standby button 
- ② Display panel
- ③ UP button 
- ④ DOWN button 
- ⑤ **syn**  button
- ⑥ **set** button
- ⑦ **volume** control
- ⑧ Antenna input (**ANT B**), BNC socket
- ⑨ Audio output (**BALANCED**), XLR-3M socket, balanced
- ⑩ Audio output (**AUDIO OUT UNBALANCED**) 1/4" (6.3 mm) jack socket, unbalanced
- ⑪ **LINE/MIC** slide switch
- ⑫ **SQ** rotary switch for squelch threshold
- ⑬ DC socket (**DC 12 V, 300 mA**) for connection of mains unit
- ⑭ Cable grip for mains cable
- ⑮ Antenna input (**ANT A**), BNC socket
- ⑯ Type plate



B Display panel

- ⑰ Frequency
- ⑱ RF signal level "**RF**"
- ⑲ Audio level "**AF**"
- ⑳ Battery charge status of transmitter
- ㉑ Channel
- ㉒ Frequency bank
- ㉓ **SYNC** display
- ㉔ **SCAN, PRESET, TUNE** menu items
- ㉕ **ANT A/ANT B** active antenna input

C SK 20 bodypack transmitter

- ① Microphone/instrument input
- ② **mute** LED, yellow (lit = muting is activated)
- ③ **power** LED, red (lit = switched on; flashing = batteries are low)
- ④ Antenna
- ⑤ Display panel
- ⑥ Input sensitivity slide switch
- ⑦ **syn**  button
- ⑧ ON/OFF button 
- ⑨ Battery compartment cover
- ⑩ Belt clip
- ⑪ **MUTE** button

D SKM 35/SKM 65 radio microphone

- ① Sound inlet basket (SKM 35 = black identification ring; SKM 65 = grey identification ring)
- ② Display panel
- ③ **mute** LED, yellow LED (lit = muting is activated)
- ④ **MUTE** button
- ⑤ Input sensitivity slide switch
- ⑥ ON/OFF button 
- ⑦ **syn**  button
- ⑧ LED power, red LED (lit = switched on; flashing = batteries are low)
- ⑨ Antenna cover
- ⑩ Battery compartment

Putting the XS WIRELESS systems into operation

Putting the receiver into operation

You can set up the receiver as a single device or mount it into a 19" rack. For information on rack mounting and optional accessories (e.g. rack mount "ears" and remote antennas), visit the XS WIRELESS product page at www.sennheiser.com.

Setting up the receiver

CAUTION

Risk of staining furniture surfaces!

Furniture surfaces are often treated with varnish, polish or synthetics which might cause stains when they come into contact with other synthetics such as the device feet.

- ▶ Do not place the receiver on delicate surfaces; if necessary, place a pad under the receiver.

- ▶ Place the receiver on a flat, even surface.

Connecting the receiver to the mains

- ▶ Connect the connector of the mains unit to the DC socket ⑬ on the receiver.
- ▶ Connect the mains unit to a wall socket. The receiver switches on, the display panel is backlit.

Connecting and aligning the rod antennas

The supplied rod antennas are suitable for all applications where – good reception conditions provided – a wireless transmission system is to be used without a large amount of installation work. To increase the range, you can use remote antennas which are available as accessories from your specialist dealer.

- ▶ Connect the two rod antennas to the BNC sockets ⑮ and ⑧ at the rear of the receiver.
- ▶ Align the antennas in a V-shape.

Connecting the amplifier/mixing console

- ▶ Use a suitable cable to connect the amplifier or mixing console to the XLR-3M socket ⑨ or the ¼" (6.3 mm) jack socket ⑩.
- ▶ For a rough adjustment of the AF audio level, set the LINE/MIC slide switch ⑪ to the corresponding position.
- ▶ Use the volume control ⑦ of the receiver to optimally adjust the AF audio level to the input of the amplifier or mixing console.

Putting the bodypack transmitter into operation

Inserting/replacing the batteries (see fig. "SK 20")

- ▶ Use two AA size batteries (1.5 V) for powering the SK 20 bodypack transmitter.
- ▶ Open the battery compartment cover (11).
- ▶ Insert the batteries. Observe correct polarity when inserting the batteries.

Connecting the microphone/instrument cable

The bodypack transmitter's audio input is designed for the connection of both condenser microphones (ME 2-2 clip-on microphone and ME 3 headmic) and instruments (e.g. guitars).

- ▶ Connect the clip-on microphone, headmic or instrument to the microphone/instrument input (1).

Attaching the clip-on microphone

- ▶ Use the microphone clip to attach the ME 2-2 clip-on microphone to clothing.
- ▶ Conduct the cable so that noise due to friction is avoided and that the microphone cable and the antenna do not cross.

Putting on the headmic

- ▶ Adjust the ME 3 headmic so that a comfortable and secure fit is ensured.
- ▶ Position the microphone so that its sound inlet is directed towards the sound source.

Attaching the bodypack transmitter to clothing

- ▶ Use the belt clip (10) to attach the bodypack transmitter to clothing. Make sure that the antenna is at least 1 cm away from the body and is not kinked.

Putting the radio microphone into operation

Inserting/replacing the batteries (see fig. "SKM 35/SKM 65")

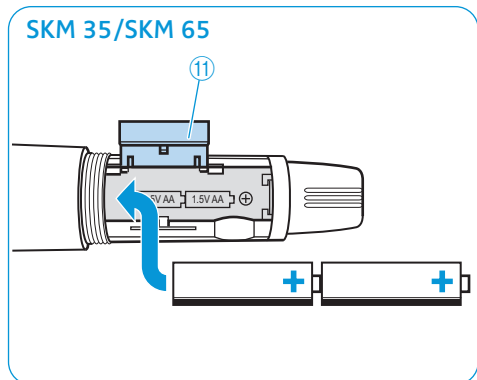
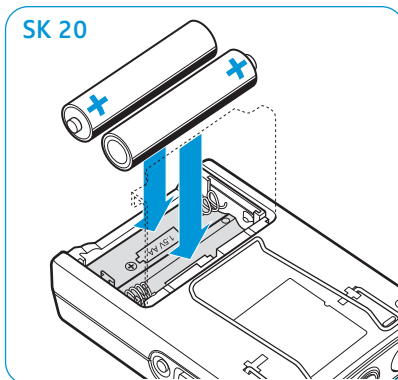

- ▶ Use two AA size batteries (1.5 V) for powering the SKM 35/SKM 65 radio microphone.
- ▶ Unscrew the lower part of the microphone body and open the battery compartment cover.
- ▶ Insert the batteries. Observe correct polarity when inserting the batteries.



Using the XS WIRELESS systems

Switching the receiver on/off

To switch the receiver **on**:

- ▶ Press the standby button  ①. The receiver switches on, the display panel is backlit.
- ▶ Check the RF signal level "RF"  on the receiver's display panel.
 - The RF signal level is not displayed: The receiver frequency is unused. You can put your transmitter into operation.
 - The RF signal level is displayed: The receiver frequency is already used. Read the chapter "Selecting and changing a receiver channel".

To switch the receiver to **standby** mode:

- ▶ Keep the standby button  ① pressed until "OFF" appears on the display panel.







To completely switch the receiver **off**:

- ▶ Disconnect the receiver from the mains by unplugging the mains unit from the wall socket.

Switching the transmitters on/off

To switch the transmitters on:

- ▶ Press the ON/OFF button . The powerLED lights up red. The display panel of the receiver and the transmitters displays the charge status of the batteries:

Display on the receiver	Display on the transmitter	Charge status
		approx. 100 %
		approx. 70 %
		approx. 30 %
		The display and the power LED are flashing. The charge status is critical.

To switch the transmitters off:

- ▶ Keep the ON/OFF button  pressed until "OFF" appears on the display panel.

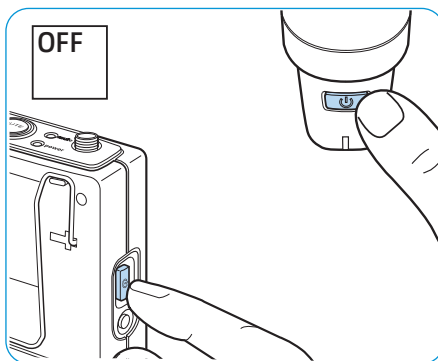
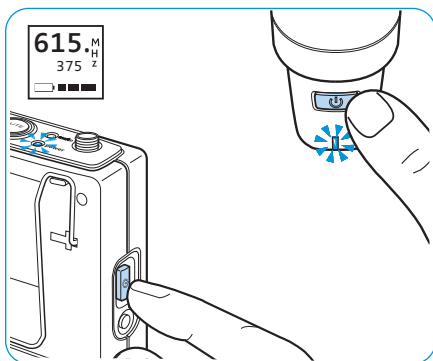

Muting the transmitters

To mute the transmitters:

- ▶ Press the **MUTE** button. The **mute** LED lights up yellow. The audio signal is muted.

To cancel the muting of the transmitters:

- ▶ Press the **MUTE** button. The **mute** LED goes off. The muting is canceled.

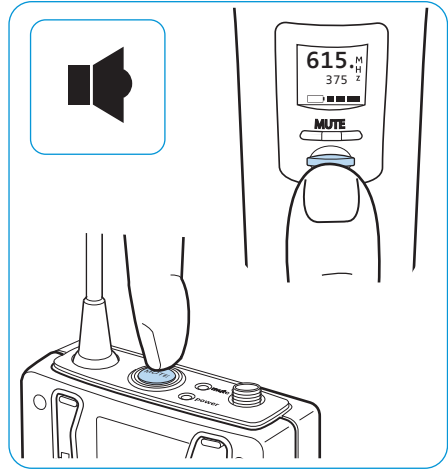
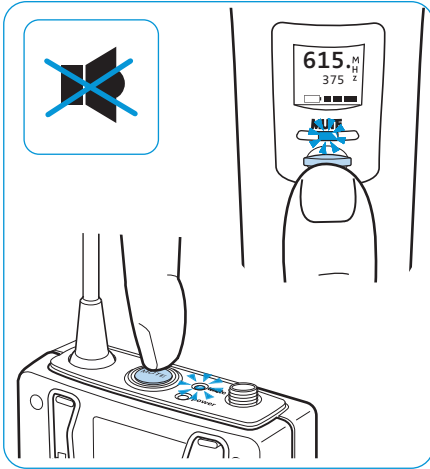

Adjusting the sensitivity

- ▶ Use the slide switch ⑥ (SK) or ⑤ (SKM) to adjust the sensitivity.

i You can vary the volume and the bass reproduction by increasing/decreasing the distance between radio microphone and mouth.

Selecting and changing a receiver channel

Make sure that all receivers are set to the same frequency bank in order to prevent interference and intermodulation to the transmitter.

Selecting a menu item and activating it

- ▶ Press the UP button ▲ ③ or DOWN button ▼ ④ to select the **TUNE**, **PRESET** or **SCAN** menu item.
- ▶ Press the **set** button ⑥ to activate the selected menu item.

Menu item	Select this menu item to ...
TUNE	manually set an unused frequency.
PRESET	select a preset channel.
SCAN	set an unused channel by automatic searching.

The menu items and their adjustment possibilities

TUNE menu item

- ▶ Use the UP button ▲ ③ or DOWN button ▼ ④ to select an unused frequency.
- ▶ Press the **set** button ⑥ to store your setting.

PRESET menu item

- ▶ Use the UP button ▲ ③ or DOWN button ▼ ④ to select a frequency bank.
- ▶ Press the **set** button ⑥ to store your setting.
- ▶ Use the UP button ▲ ③ or DOWN button ▼ ④ to select a channel.
- ▶ Press the **set** button ⑥ to store your setting.

SCAN menu item

Pressing the **set** button ⑥ to activate the **SCAN** menu item automatically selects an unused channel.

To select another frequency bank:

- ▶ Press the UP button ▲ ③ or DOWN button ▼ ④.
- ▶ Press the **set** button ⑥ to store your setting.

Synchronizing a transmitter with the receiver

The receiver always transfers the frequencies to the transmitter.

- ▶ Switch the transmitter and the receiver on.
- ▶ Keep the **sync** button ⑦ of your transmitter pressed until the **SYNC** display ②③ flashes on the receiver's display panel.
- ▶ Press the **sync** button ⑤ of the receiver to transfer the selected frequency to the transmitter.

 You can also synchronize a switched-off transmitter with the receiver. The transmitter automatically switches on during the synchronization process.

Adjusting the squelch threshold

Interference of the RF signal due to other transmission links can be eliminated as follows:

- ▶ Switch the transmitter off. The receiver should no longer receive a signal.
- ▶ If the receiver still receives a signal, use the rotary switch for squelch threshold "SQ" ⑫ to increase the squelch threshold so that the signal will no longer be received. If the signal cannot be eliminated in this way, set the transmitter and the receiver to a different channel.
- ▶ Switch the transmitter on again and check if the receiver receives the transmitter signal.

 If the squelch threshold is adjusted too high, the transmission range will be reduced. Therefore, always adjust the squelch threshold to the lowest possible setting.

Cleaning and maintaining the XS WIRELESS systems

CAUTION

Liquids can damage the electronics of the products!

Liquids entering the housing of the products can cause a short-circuit and damage the electronics.

- ▶ Keep all liquids away from the products.
- ▶ Do not use any solvents or cleansing agents.

-
- ▶ Before cleaning, disconnect the receiver from the mains.
 - ▶ Only use a soft, slightly damp cloth to clean the products.

If a problem occurs ...

Problem	Cause	Solution	Page
No operation indication	Batteries are flat	Replace the batteries.	8
	No mains connection (receiver)	Check the connections of the mains unit.	7
No RF signal	Transmitter and receiver are not on the same channel	Set transmitter and receiver to the same channel.	10
	Transmission range is exceeded	Reduce the distance between transmitter and receiver.	–
RF signal available, no audio signal	Receiver's squelch threshold is adjusted too high	Reduce the squelch threshold.	11
Audio signal has a high level of background noise or is distorted	Transmitter sensitivity is adjusted too low or too high	Adjust the sensitivity on the transmitter.	10
	Receiver's audio output level is adjusted too low or too high	Use the volume control ⑦ to adjust the audio level.	7
Interference of the RF signal	Distance between transmitting and receiving antennas is too small	Distance > 5 m	–
	Several transmitters/radio microphones are used simultaneously and the distance between two transmitters is too small	Distance > 20 cm	–

Specifications

System

Modulation	wideband FM
Frequency ranges	A: 548-572 MHz GB: 606-630 MHz B: 614-638 MHz C: 766-790 MHz E: 821-832 MHz and 863-865 MHz
Switching bandwidth	24 MHz (range E: 13 MHz)
Frequencies	960 (range E: 520), tuneable in steps of 25 kHz 8 frequency banks, each with up to 12 factory-preset channels
Signal-to-noise ratio	≥ 103 dBa
THD	$\leq 1\%$
Temperature range	0°C to +40°C

EM 10 receiver

Receiver principle	true diversity
Sensitivity (at peak deviation)	$< 3 \mu\text{V}$ at 52 dBa _{rms S/N}
Adjacent channel rejection	≥ 60 dB
Intermodulation attenuation	≥ 50 dB
Blocking	≥ 65 dB
AF frequency response	50 – 16,000 Hz
Pilot tone	32.768 kHz
Antenna input	2 BNC sockets, 50 Ω
AF output voltage (at peak dev., 1 kHz AF)	¼" (6.3 mm) jack socket (unbalanced): +8 dBu XLR socket (balanced): +14 dBu
Power supply	12 V _{DC} nom. / 300 mA
Dimensions	200 x 42 x 127 mm
Weight	730 g

Transmitter	SK 20	SKM 35	SKM 65
RF output power	10 mW	10 mW	10 mW
AF frequency response	50 – 16,000 Hz (Line) 80 – 16,000 Hz (Mic)	80 – 16,000 Hz	80 – 16,000 Hz
AF input	3.5 mm jack socket	–	–
Nom. input voltage (Mic/Line)	0.5 V _{RMS} / 1.8 V _{RMS} at -30 dB gain	–	–
Power supply	2 AA size batteries, 1.5 V	2 AA size batteries, 1.5 V	2 AA size batteries, 1.5 V
Operating time	approx. 10 hrs	approx. 10 hrs	approx. 10 hrs
Dimensions	66 x 96 x 24 mm	250 x 54 mm	250 x 54 mm
Weight	95 g	240 g	240 g
Microphone type	–	dynamic	condenser, pre-polarized
Input sensitivity	–	1.5 mV/Pa	1.8 mV/Pa
Pick-up pattern	–	cardioid	super-cardioid
Max. SPL	–	149 dB SPL	144 dB SPL

Microphones	ME 2-2	ME 3
Transducer principle	condenser, pre-polarized	condenser, pre-polarized
Sensitivity	5 mV/Pa	1.6 mV/Pa
Pick-up pattern	omni-directional	cardioid
Max. SPL	142 dB	150 dB

In compliance with (EM, SK and SKM)

Europe:

CE	EMC	EN 301489-1/-3/-9
	Radio	EN 300422-1/-2, EN 301440, EN 301357
	Safety	EN 60065, EN 62311 (SAR)

Approved by (SK)

Canada:

Industry Canada RSS 123 (210),
IC 2099A-XSWSK
FCC-Part 74, FCC-ID: DMO XSWSK
FCC-Part 15 C, limited to 698 MHz

Approved by (SKM)

Canada:

Industry Canada RSS 123 (210),
IC 2099A-XSWSKM
FCC-Part 74, FCC-ID: DMO XSWSKM
FCC-Part 15 C, limited to 698 MHz

Approved by (EM)

Canada:

Industry Canada RSS 123, IC 2099A-XSWEM
FCC-Part 15 C, FCC-ID: DMO XSWEM

Connector assignment

EM 10

¼" (6.3 mm)
mono jack plug,
unbalanced

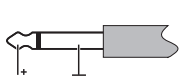

EM 10

XLR-3F
connector,
balanced

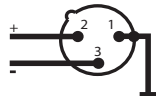

EM 10

DC connector for
power supply



SK 20

3.5 mm jack plug
(Mic)

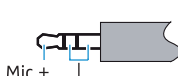

SK 20

3.5 mm jack plug
(Line)

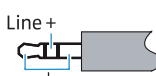

Manufacturer Declarations

Warranty

Sennheiser electronic GmbH & Co. KG gives a warranty of 24 months on this product. For the current warranty conditions, please visit our web site at www.sennheiser.com or contact your Sennheiser partner.

In compliance with the following requirements

- RoHS Directive (2002/95/EC)
- WEEE Directive (2002/96/EC)



Please dispose of the products at the end of their operational lifetime by taking them to your local collection point or recycling center for such equipment.



- Battery Directive (2006/66/EC)



The batteries supplied with the transmitters can be recycled. Please dispose of them as special waste or return them to your specialist dealer. In order to protect the environment, only dispose of exhausted batteries.

CE Declaration of Conformity

- EM10: **CE 1856**, SK20, SKM 35, SKM 65: **CE 1856** 
- R&TTE Directive (1999/5/EC)
- EMC Directive (2004/108/EC)
- Low Voltage Directive (2006/95/EC)

The declaration is available at www.sennheiser.com. Before putting the products into operation, please observe the respective country-specific regulations.

Statements regarding FCC and Industry Canada

This device complies with Part 15 of the FCC Rules and with Industry Canada licence-exempt RSS standard(s). Operation is subject to the following two conditions: (1) this device may not cause harmful interference, and (2) this device must accept any interference received, including interference that may cause undesired operation.

This equipment has been tested and found to comply with the limits for a Class B digital device, pursuant to Part 15 of the FCC Rules. These limits are designed to provide reasonable protection against harmful interference in a residential installation. This equipment generates, uses and can radiate radio frequency energy and, if not installed and used in accordance with the instructions, may cause harmful interference to radio communications. However, there is no guarantee that interference will not occur in a particular installation. If this equipment does cause harmful interference to radio or television reception, which can be determined by turning the equipment off and on, the user is encouraged to try to correct the interference by one or more of the following measures:

- Reorient or relocate the receiving antenna.
- Increase the separation between the equipment and receiver.
- Connect the equipment into an outlet on a circuit different from that to which the receiver is connected.
- Consult the dealer or an experienced radio/TV technician for help.

Changes or modifications made to this equipment not expressly approved by Sennheiser electronic Corp. may void the FCC authorization to operate this equipment. Before putting the device into operation, please observe the respective country-specific regulations!

Sennheiser electronic GmbH & Co. KG

Am Labor 1, 30900 Wedemark, Germany
www.sennheiser.com

Printed in Taiwan, Publ. 01/12, 542696/A03

